

HOTEL CHILLED BEAM IQ STAR SILENCIA

TECHNICAL CATALOGUE

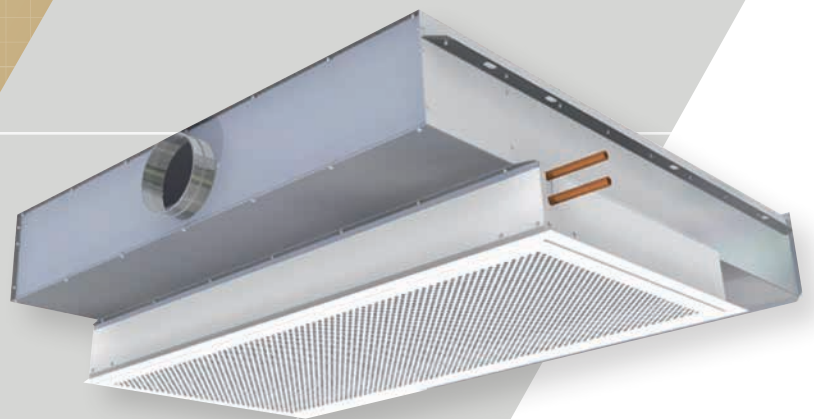

IQ STAR SILENCIA HOTEL CHILLED BEAM

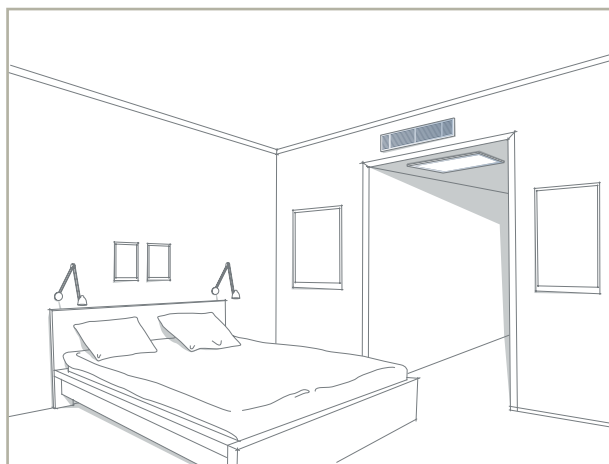

Silencia unit is designed for use in hotel bedrooms, individual hospital wards and cellular offices. Silencia unit ensures good indoor air climate while the noise level is very low. It provides high cooling capacity through optimal utilisation of its cooling coil already while the air pressure and airflows are low.

The required primary volume flow for fresh air is supplied through a duct into which nozzles are fitted. As a result secondary air is induced through a horizontal water coil for heating or cooling, or heating and cooling.

At the same time, the installation height of the product is kept at an absolute minimum which enables maximum room height in e.g. the entrance to a hotel room.

QUICK SELECTION

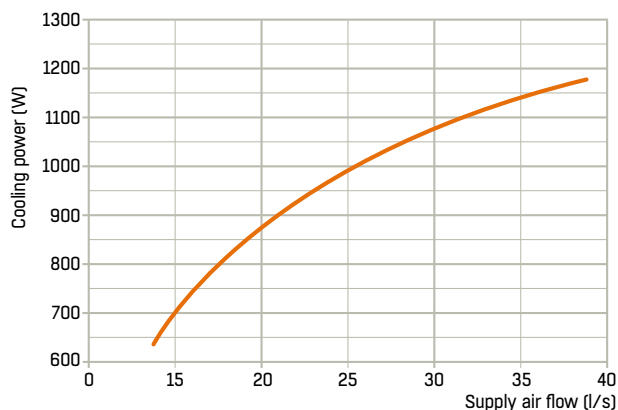

The diagram shows the total cooling power P_{tot} in W at a total pressure of 70 Pa and a water flow $q_w = 0.05$ l/s. Temperature difference between room air and supply air $\Delta t = 8$ °C and the temperature difference between mean water temperature and room temperature, $\Delta t_w = 8$ °C.

KEY FEATURES

- Cooling and / or heating
- 4 different airflow levels
- Low noise level

SPECIFICATIONS

- Silencia unit for bulkhead installation
- 2 or 4 pipes water coil for cooling or cooling and heating
- Right or left side connection for water
- Fixing by rods
- Low noise level

PRODUCT CODE EXAMPLE

Hotel chilled beam QVFH-100-01-02-2.

INSTRUCTIONS, ADJUSTMENT AND MAINTENANCE

Instructions for installation, adjustment and maintenance are supplied with each product. The instructions are also available on our web pages at www.flaktgroup.com.

TECHNICAL DATA AND DIMENSIONING

The full scale dimensioning is done with the FläktGroup product selection program Select that is available on our web pages at www.flaktgroup.com.

TECHNICAL AND SOUND DATA, CONSTRUCTION AND FUNCTION

COOLING POWER

Nozzle	Airflow, l/s	P _{tot} W at Δt, °C			P _{coil} W at Δt, °C			L _{A10} , dB(A)
		6	8	10	6	8	10	
3	13.4	510	637	764	381	508	635	
5	21.1	751	934	1117	548	731	914	
7	30.3	892	1092	1292	601	801	1001	
9	36.4	977	1186	1395	628	837	1046	

The data is given at total pressure drop 70 Pa on the air side, water flow 0.05 l/s , Pressure drop Δp_w = 10 kPa , temperature difference room air and supply air Δt = 8 °C

HEATING POWER

Nozzle	Airflow, l/s	P _{coil} W at Δt, °C			L _{A10} , dB(A)
		10	15	20	
3	13.4	414	621	828	
5	21.1	559	838	1117	
7	30.3	595	893	1191	
9	36.4	613	919	1225	

The data is given at total pressure drop 70 Pa on the air side, water flow 0.05 l/s , Pressure drop Δp_w = 11 kPa .

SOUND POWER LEVEL

Silencia	Correction K _{oct} dB Octave band, mid-frequency, Hz							
	63	125	250	500	1000	2000	4000	8000
100	4	3	4	3	0	-8	-17	-18
Tol +/-	4	2	2	1	1	2	3	8

The sound power levels for every octave band are obtained by adding together the sound pressure level L_{A10} , dB(A), and the corrections K_{oct} given in the table above, according to the following formula:

$$L_W = L_{A10} + K_{oct}$$

SOUND ATTENUATION

The average sound attenuation ΔL of the Silencia hotel chilled beam from duct to room includes the end reflection of the connecting duct.

Silencia	Sound attenuation in supply duct for the beam ΔL, dB							
	Octave band, mid-frequency, Hz							
	63	125	250	500	1000	2000	4000	8000
100	26	17	16	20	19	19	24	20

CONDITIONS FOR COOLING POWER TABLES

Total cooling effect of beam , P_{tot} = cooling effect of coil, P_{coil} + cooling effect of supply air, P_{air}

- The assumed pressure drop on the air side is 70 Pa.
- The cooling effect of supply air is based on an undertemperature of 8 °C , when compared to the room temperature.
- The effects for other water flows than 0.05 l/s can be found in the FläktGroup product selection tool, Select.

Note! The tables here are based on tests done according to the

EN 15116 standard. The purpose of this standard is to be able to compare different chilled beams on the same terms. The method requires a nonexisting temperature difference between the air entering the beam coil and the air at 1.1 m above floor surface.

To achieve this, the walls in the test room are cooled. In actual conditions, the temperature difference is normally 1 °C . This is why the temperature should be increased by 1 °C to avoid over dimensioning of the beam. This means that the table value concerned can be increased by 10 %.

DEFINITIONS

q _i	Supply airflow, l/s
P _{tot}	Total cooling effect, W
P _{coil}	Cooling effect of the coil, W
P _{coil heat}	Heating effect of the coil, W
Δt	Difference between room air temperature and average water temperature, °C
Δp _w	Pressure drop water, kPa
Δt _w	(°C) = P _{batt} (W) / 208
Δt _w	(US imperial) - Δt _w (°F) = P batt (BTU/tim) / 81177
L _{A10}	Sound pressure level in a room with 10 m ² room absorption, dB(A)

CONSTRUCTION AND FUNCTION

Silencia is available in one size and is made for a bulkhead installation. The unit without induction grill and outlet grill is first installed in the ceiling with threaded rods. Afterwards you easily install the both grills with the telescopic solution to get a good finish against the ceiling and wall for the induction grill and outlet grill.

In order to handle different airflow levels the unit can be equipped with 3, 5, 7 or 9 nozzles.

The unit can be equipped with two plenums and 2 connections. By using this solution you can connect a damper with actuator to one of the plenums and it gives you the opportunity to shut off one of the plenums and run it in an energy saving mode with lower airflow. In normal conditions when the room is occupied, both plenums are used, with an open damper. And when the room is unoccupied with lower need for cooling and fresh air, the damper is closed and only one plenum is used.

It can be delivered with or without an outlet grille if you want to use a different grille

MATERIAL AND SURFACE FINISH

The casing is mainly made of galvanized steel sheet. The coil is made of copper tubes and aluminium fins, connection size is Øout 15 mm (thickness 1 mm).

Maximum working pressure 1.5 Mpa.

DIMENSIONS

QVFH-100-bb-cc-d

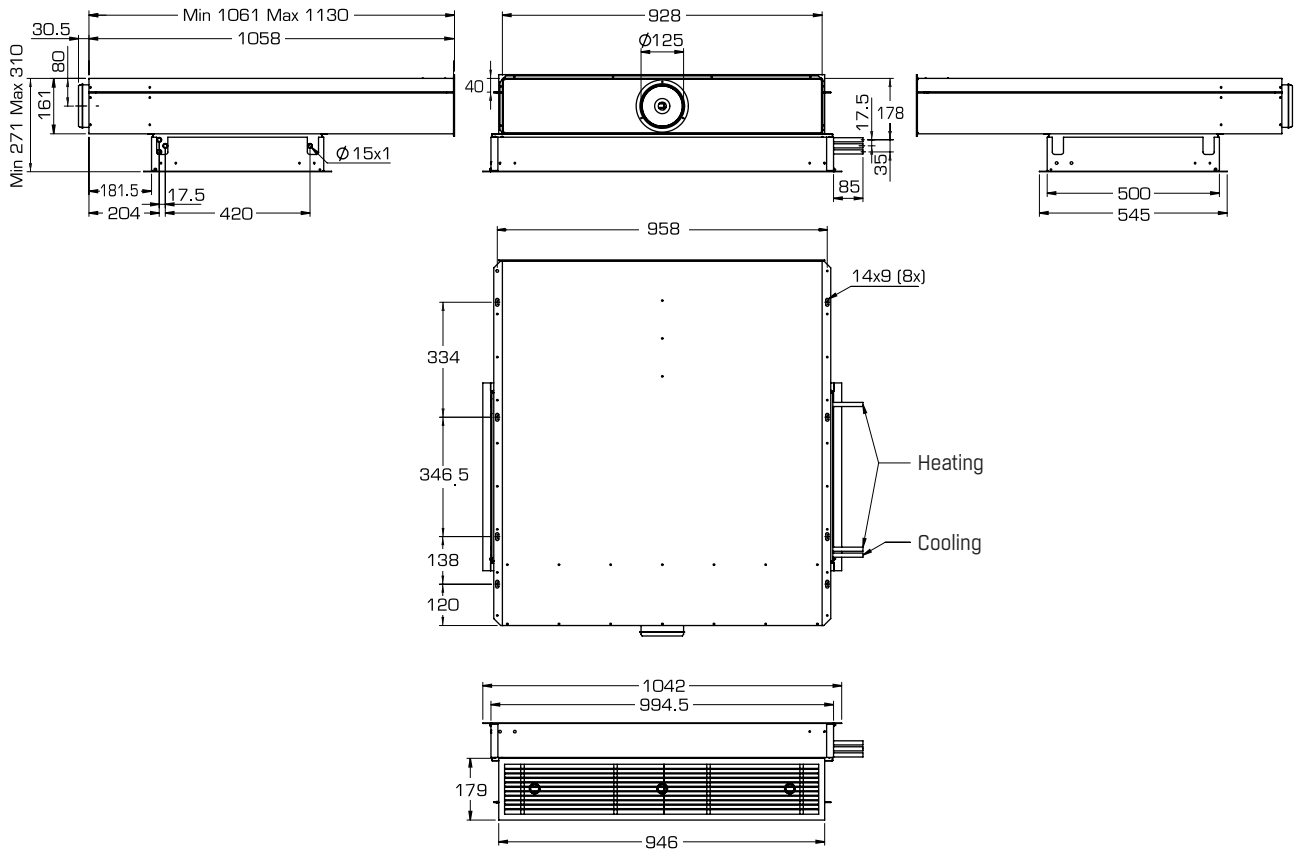

PRODUCT CODE

Hotel chilled beam Silencia

QVFH-100-bb-cc-d

Coil (bb) _____

01 = Cooling

02 = Cooling and heating

Nozzle configuration (cc) _____

01 = 3 nozzles

02 = 5 nozzles

03 = 7 nozzles

04 = 9 nozzles

Connections (d) _____

1 = Right side water connection, duct connection \varnothing 125 mm, without outlet grill

2 = Right side water connection, duct connection \varnothing 125 mm, with outlet grill

3 = Right side water connection, 2 plenums, without outlet grill

4 = Right side water connection, 2 plenums, with outlet grill,

5 = Left side water connection, duct connection \varnothing 125 mm, without outlet grill

6 = Left side water connection, duct connection \varnothing 125 mm, with outlet grill

7 = Left side water connection, 2 plenums, without outlet grill

8 = Left side water connection, 2 plenums, with outlet grill

Right
d = 1, 2

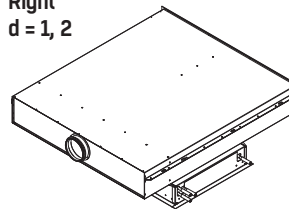

Left
d = 5, 6

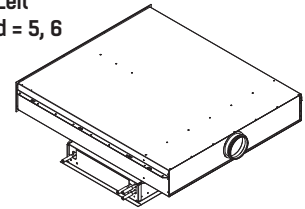

Right
d = 3, 4

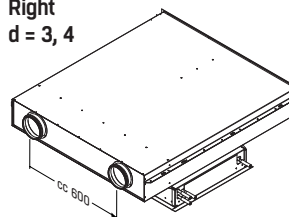

Left
d = 7, 8

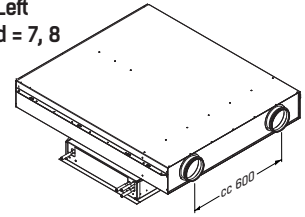

EXCELLENCE IN SOLUTIONS

FläktGroup is the European market leader for smart and energy efficient Indoor Air and Critical Air solutions to support every application area. We offer our customers innovative technologies, high quality and outstanding performance supported by more than a century of accumulated industry experience. The widest product range in the market, and strong market presence in 65 countries worldwide, guarantee that we are always by your side, ready to deliver Excellence in Solutions.

PRODUCT FUNCTIONS BY FLÄKTGROUP

Air Treatment | Air Movement | Air Diffusion | Air Distribution | Air Filtration
Air Management & ATD's | Air Conditioning & Heating | Controls | Service

» Learn more on www.flaktgroup.com
or contact one of our offices